

50 ST E1

2 speed manual, 1 speed electric, 24VDC

Andersen Powered Winch: RA2050011400, RA2050001400
 50 ST E1 - Self tailing, E1 electric motor,
 2 speed manual, 1 speed electric, 24VDC

Product Information:

Power Ratio	1st speed = 15.7:1, 2nd speed = 49.3:1
Gear Ratio	1st speed = 2.8:1, 2nd speed = 8.8:1
Maximum Working Load	1000kg (2200lb)

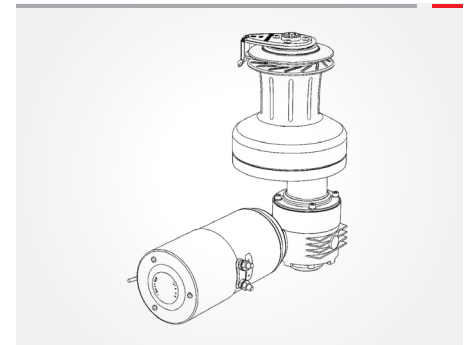

Physical Dimensions:

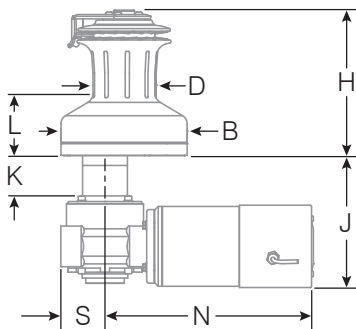

Rope Size.....	8-14mm (5/16 - 9/16")
Drum Ø D.....	89mm (3 1/2")
Base Ø B.....	181mm (7 1/8")
Height H.....	208mm (8 3/16")
Line Entry L.....	90mm (3 9/16")*
Max Deck K.....	57mm (2 1/4")
Gear Length S.....	65mm (2 9/16")
Motor Depth J.....	191mm (7 1/2")
Motor Length N....	300mm (11 13/16")
Weight.....	21kg (46.3lb)

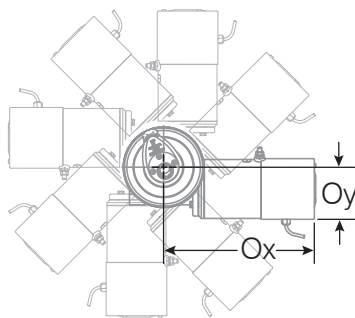

MOTOR OFFSET

Minimum O _x	266mm (10 1/2") [^]
O _y	144mm (5 11/16") [^]
Minimum O _y	117mm (4 5/8") [^]
O _x	303mm (11 15/16") [^]

* Extensions available to suit thicker decks.
[^] Values with motor in optimum position to minimise O_x or O_y. O_y value includes allowance for push button cable and fitting on the motor housing. Motor can be rotated at 45° intervals which will change O_x and O_y values.

Full installation dimensions can be found in the Product Manuals - available to download at www.andersenwinches.com.

Wiring Diagram:

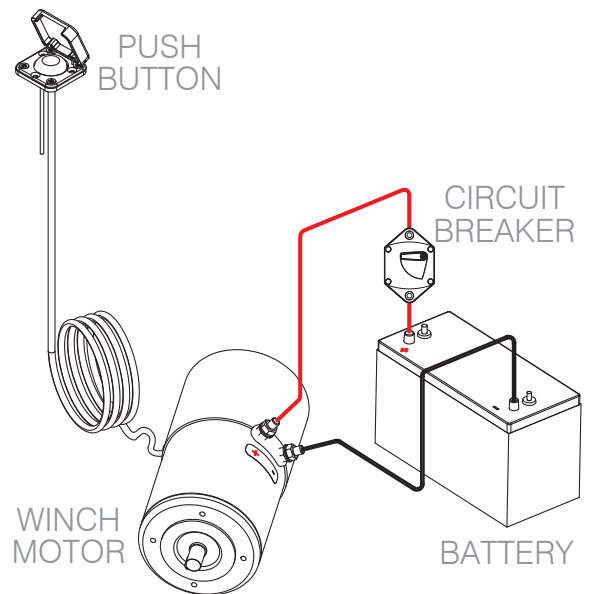

Motor units are supplied with installation manual, push button and cable terminals. Circuit breaker available separately. See motor unit product manual for push button to motor unit cable connection details.

Electrical Installation:

WIRE LENGTH ¹	WIRE SIZE	FUSE or CIRCUIT BREAKER ²	START-UP MOTOR CURRENT ³	ADDITIONAL BATTERY CAPACITY PER WINCH ⁴	MINIMUM BATTERY BANK CAPACITY ⁵
0-3m (0-10ft)	25mm ²	70A	300A	20Ah	150Ah
3-8m (10-27ft)	35mm ²				

- Wire length = length from battery to motor.
- Must be a 'slow blow' or 'long delay' type to allow for start-up current spike. Suitable circuit breakers available separately.
- The current "spike" generated at motor start-up, for a period of no more than 0.1 seconds.
- This is the minimum additional Ah (Ampere hours) battery capacity that will be required to run one winch. Assuming a single winch, used for of 15 minutes (0.25hr) per day at a load of 1/2 MWL = 145A. This equates to an Ah figure of 36Ah. The number of Ah for all other electrical equipment must be added to this figure to determine the Ah requirement of the total battery bank capacity. A good rule of thumb is to use 3 x this total Ah figure as the minimum capacity for your battery bank. We recommend you contact a qualified marine electrician for advice.
- This is the minimum recommended battery bank capacity to ensure minimum 10.5V is maintained in 12V systems, and 21V in 24V systems at start up current. Based upon battery CCA value at -18C and assuming fully charged batteries and no losses in wiring and connections.

Performance:

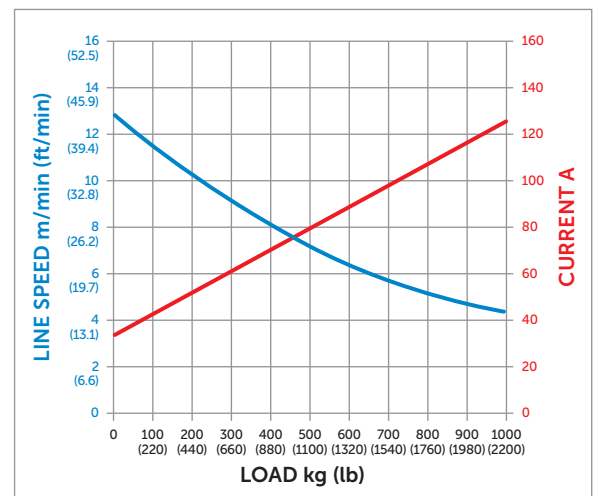

The motor will cut-out at pre-determined current and temperature limits.